

CHANGES BY	REV	DESCRIPTION	DATE	APPROVED

STORAGE/DISPENSING OF CLASS 1A AND DISPENSING OF CLASS 1B FLAMMABLE LIQUIDS PROHIBITED.

ESTIMATED SHIPPING DIMENSIONS:
 LENGTH = 11'-11"
 DEPTH = 6'-3"
 HEIGHT = 9'-5"

GENERAL NOTES:
 1- ALL MATERIAL AND WORKMANSHIP SHALL CONFORM WITH THE REQUIREMENTS OF THE LATEST REVISION OF THE UBC, IBC AND STATE BUILDING CODES. DESIGN ACCORDING TO ASCE, ASD, AND WITH ANS/AISC 7.
 2- NO LOADS OTHER THAN THOSE GIVEN UNDER "DESIGN DATA" BELOW SHALL BE IMPOSED ON THE "STRUCTURE."
 STRUCTURAL QUALITY ASTM SPECIFICATION, A36 FRTOS WELDING WIRE
 DESIGN DATA IN ACCORANCE WITH ANS/AISC 7.

MINIMUM ROOF LIVE LOAD (PSF) = 40
 Pg: GROUND SNOW LOAD (PSF) = 40
 V: WIND VELOCITY (MPH) = 90
 SEISMIC DESIGN CATEGORY : C

FOUNDATION NOTES:
 THE FOUNDATION DRAWING IS A SUGGESTION ONLY. CHANGES MAY BE NECESSARY DUE TO LOCAL BUILDING REGULATIONS AND SITE CONDITIONS.
 1- THE PAD PERIMETER SHOULD BE AT LEAST 24" LARGER THAN THE BUILDING, BOTH IN LENGTH AND WIDTH.
 2- THE FOUNDATION SHOULD BE FORMED ON NATURAL UNDISTURBED SOIL CAPABLE OF SUSTAINING 2,000 PSF.
 3- GRANULAR BASED GRAVEL OR CRUSHED STONE SHOULD BE COMPACTED TO A DEPTH OF 4". THE SLAB SHOULD CONSIST OF 8" THICK 2,000 PSI CONCRETE.
 4- FINISH SURFACE SHOULD BE LEVEL AND THEN INSTALL 1/2" X 8" ANCHOR BOLTS INTO THE TIE DOWNS ATTACHED TO THE BUILDING CORNERS.

ALL DIMENSIONS SHOWN ON THIS PRINT ARE FOR YOUR REFERENCE. TOLERANCES ARE ±1" UNLESS OTHERWISE NOTED.

DATE: 03/16/18
 DRAWN BY: JAD

CUSTOMER

MODEL NO. ZHTS2 (FL1206)
 QUOTE NO. -
 ORDER NO. -

APPROVAL PRINT

THIS PRINT IS CONFIRMATION OF YOUR ORDER AND ILLUSTRATES THE APPROXIMATE LOCATION OF FACTORY INSTALLED OPTIONS. CUSTOMER APPROVAL IS REQUIRED BEFORE MANUFACTURING CAN BEGIN. ANY CHANGES MADE AFTER CUSTOMER APPROVAL, MAY INCUR EXTRA CHARGES AND DELAY ESTIMATED DELIVERY.

SIGNATURE _____ DATE _____

ESTIMATED SITE READY DATE _____

LEGAL NOTE
 THIS DRAWING IS THE PROPERTY OF U.S. CHEMICAL STORAGE, LLC. ANY PUBLICATION OF THIS DRAWING IN WHOLE OR IN PART IS STRICTLY FORBIDDEN. ANYONE DOING SO WILL BE PROSECUTED UNDER THE FULL EXTENT OF THE LAW.

Customer is responsible to check with appropriate agencies to determine if any third party or local approvals are necessary. Customer is responsible to determine the classification and set back of the storage building depending on the type and quantity of the chemicals being stored. Local Agency may require additional equipment to be added to this unit after their plan review process. Additional equipment is not included in the quotation.

U.S. CHEMICAL STORAGE
 MANUFACTURING FACILITY
 1806 River Street, Hwy. 268 W.
 Wilkesboro, NC 28697
 PHONE: (800) 233-1480
 FAX: (800) 838-0045

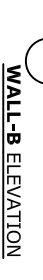
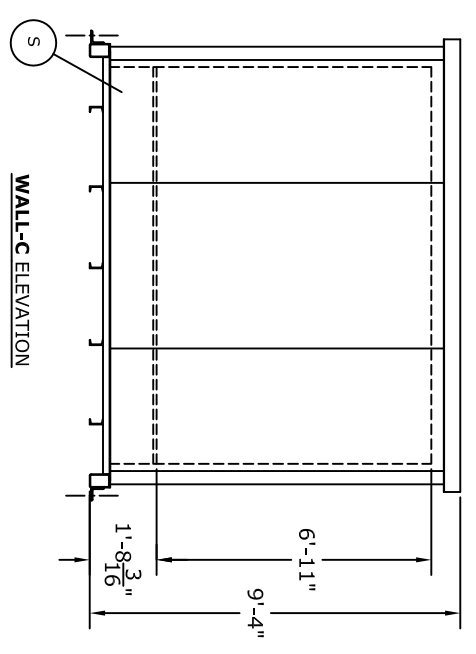
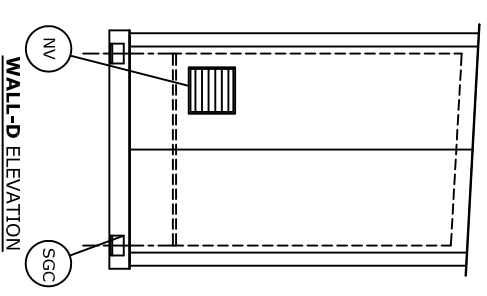
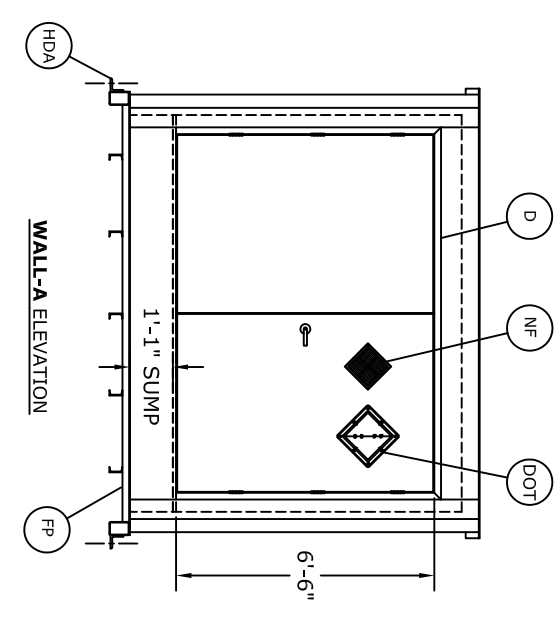
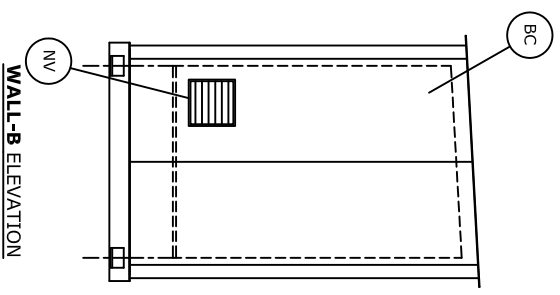
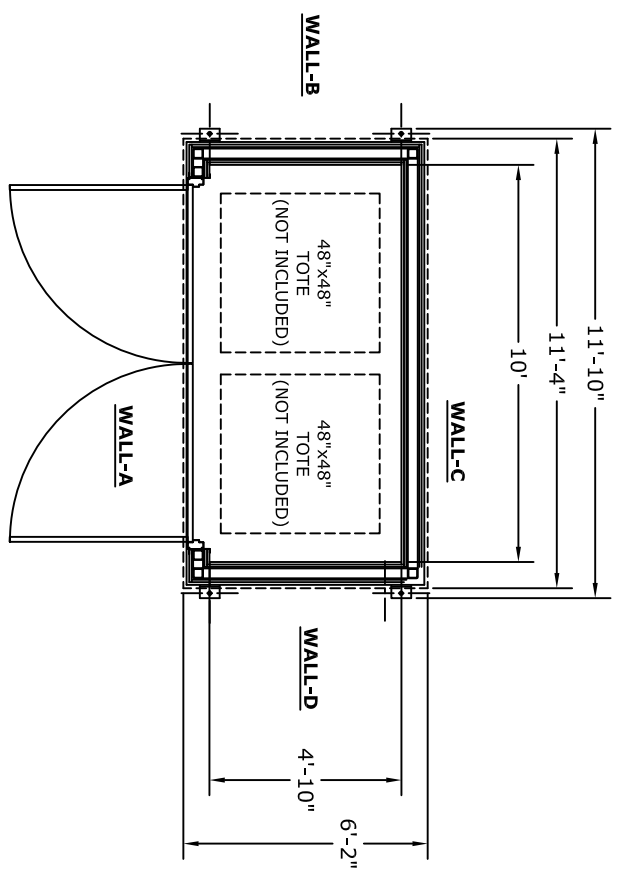
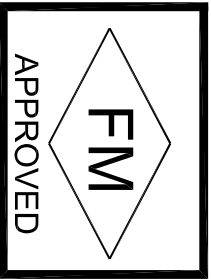

- LEGEND**
- DOT- DEPARTMENT OF TRANSPORTATION FLIP CHART PLACARD
 - NF- NATIONAL FIRE PROTECTION ASSOCIATION 704 SIGN
 - HDA- HOLD DOWN ANGLE (4)
 - S- SUMP (391 GAL CAPACITY)
 - FP- FORKLIFT POCKETS
 - SGC- STATIC GROUND CONNECTOR
 - BC- BUILDING COLOR: BLEACHED BONE U.N.O.
 - NV- NATURAL VENTILATION WITH RAIN LOUVRE w/ FIRE DAMPER (2)
 - D- 108"W x 78"H SINGLE LEAF DOOR, 1.5 HR FIRE RATED (1)

